

Electromagnetic Locks

Indoor Series



The indoor series feature UL294 for all models and UL1034 & UL 864 for models 10001 and 10010-254. The new certifications reaffirm our pursue and standards when it comes to quality and safety across our products. These locks are recommended for applications which require higher levels of access control or connection to fire alarm systems.

Standard Features

- High reliability
- Anodized aluminum casing
- MOV provides spike and surge protection
- Anti-Residual magnetism function
- Dual voltage 12/24 VDC field selectable

Standard Options

- Bond sensor output & Bi-color LED (for locked/unlocked status)
- Door status sensor (for open/closed status)
- Relock time delay (1-80 seconds)

Patents, Approvals, and Listings

- UL 294 listed
- UL 1034, UL 864 listed
(For 10001, 10010-254)

New Bi-Color Square LED Design



Indoor Series Electromagnetic Locks

Models	Holding Force (lbs)	Voltage (VDC)	Current draw	Standard Options	Optional Brackets	
					Narrow Frame/Outswing Door	Inswing Door
Single Magnet						
10001	600	12/24	500mA/12VDC 250mA/24VDC	—	L-300 EM-10001L	LZ-300N EM-10001LZ
10010-254 	1200	12/24	500mA/12VDC 250mA/24VDC	—	L-500	LZ-500N
10002	600	12/24	500mA/12VDC 250mA/24VDC	M, DS, TD	L-300 EM-10001L	LZ-300N EM-10001LZ
10020-254	1200	12/24	500mA/12VDC 250mA/24VDC	M, DS, TD	L-500	LZ-500N
Double Magnets						
10004	600	12/24	500mA/12VDC 250mA/24VDC	—	L-300 (x2)	LZ-300N (x2)
10040-254	1200	12/24	500mA/12VDC 270mA/24VDC	M, DS, TD	L-500 (x2)	LZ-500N (x2)
10005	600	12/24	500mA/12VDC 250mA/24VDC	M, DS, TD	L-300 (x2)	LZ-300N (x2)
10060-254	1200	12/24	500mA/12VDC 250mA/24VDC	—	L-500 (x2)	LZ-500N (x2)

Notes:

DS: Door status sensor

M: Bond sensor & Bi-color LED indicator

TD: Relock time delay

Indoor Series Electromagnetic Locks



10001



10002



10004



10005



10010-254



10020-254



10040-254



10060-254

Dimensions

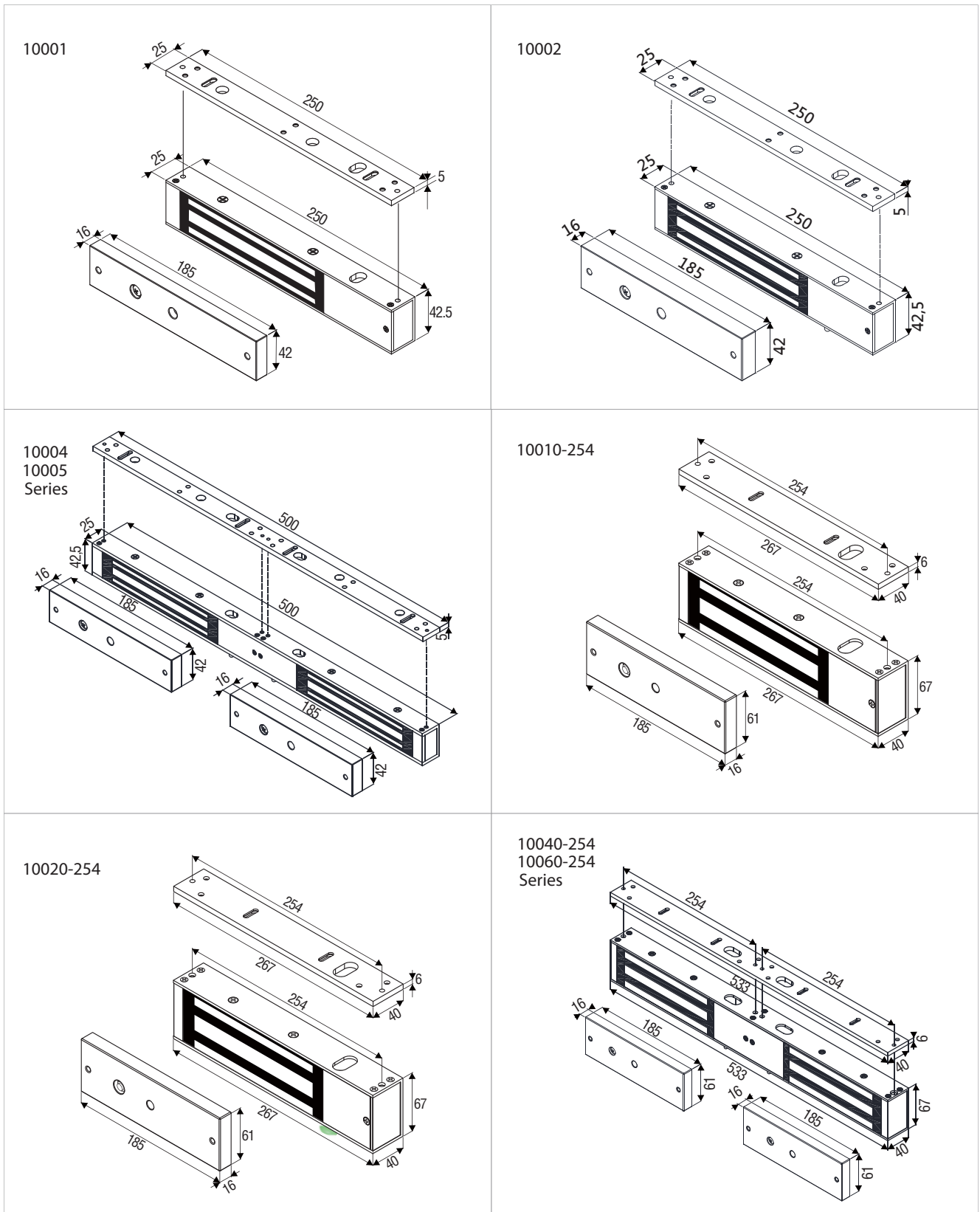

All dimensions in mm

Warranty

The product is warranted against defects in material and workmanship while used in normal service for a period of 2 year from the date of sale to the original client. The GEM policy is one of continual development and improvement; therefore GEM reserves the right to change specifications without notice.