

Outswing narrow frame doors

L-NH300AU Bracket

The A value in the table below shows the minimum requirement distance of the door frame for different electromagnetic lock model.

Magnet Grade	A Value	Optional Brackets
● 600 LBS	42 mm	L-NH300AU
800 LBS	48 mm	L-NH300AU
1200 LBS	60 mm	L-NH500AU



Application for the Electromagnet: EM-NH300 Series

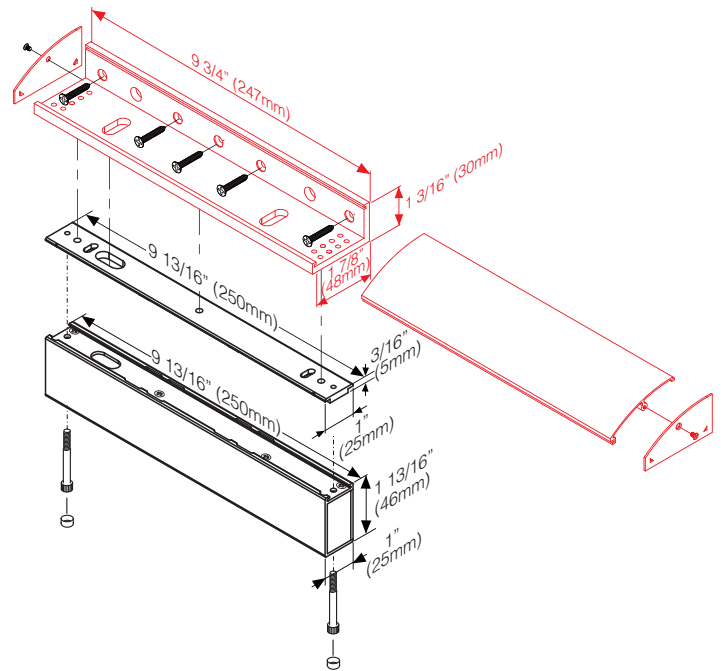
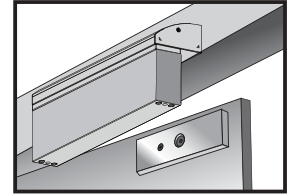
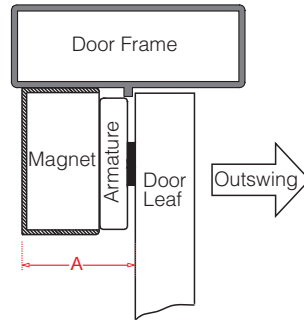
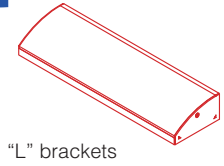

Installation of L bracket on Outswing Doors

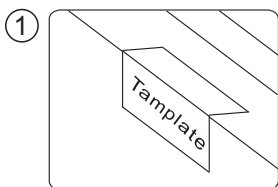

1 Fold the mounting template 90° angle along the dotted line.

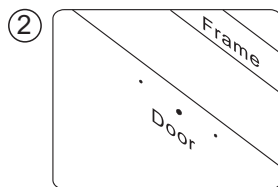

2 Drill the holes marked on the template.

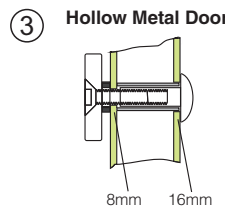

Drill a hole 8 mm in diameter through the door. Enlarge the hole to 16 mm from outside.

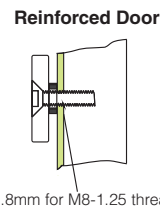

Drill a hole 6.8mm in diameter from inside. Screw with a M8-1.25 thread.

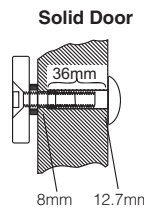

Drill a hole 8mm in diameter through the door. Enlarge the hole to 12.7mm from outside. The thickness of the door is 36mm.

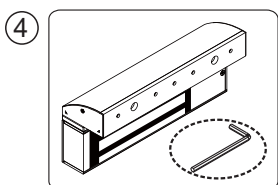

4 Assemble the electromagnet and L bracket with an Allen wrench.

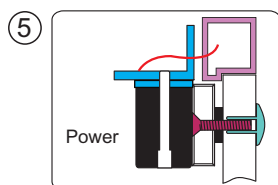

Turn on the power of electromagnet. Let the electromagnet and the armature plate bond together. Press L bracket against the door frame.

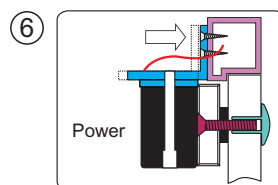

Fasten L bracket on the door frame.

Finish

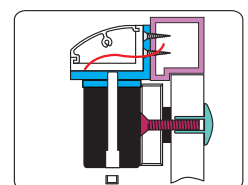

Test the unit. Tap the plugs into the electromagnet