

Outswing narrow frame doors

L-GEM-800 Bracket

The A value in the table below shows the minimum requirement distance of the door frame for different electromagnetic lock model.

Magnet Grade	A Value	Optional Brackets
300 LBS	38 mm	L-GEM-300
600 LBS	42 mm	L-GEM-600
● 800 LBS	48 mm	L-GEM-800
1200 LBS	60 mm	L-GEM-1200

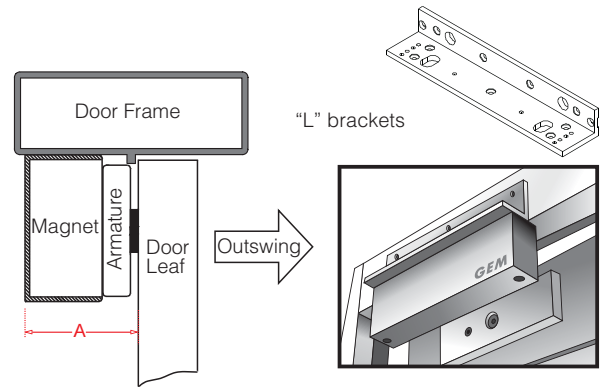

Application for the Electromagnet: GEM-800 Series

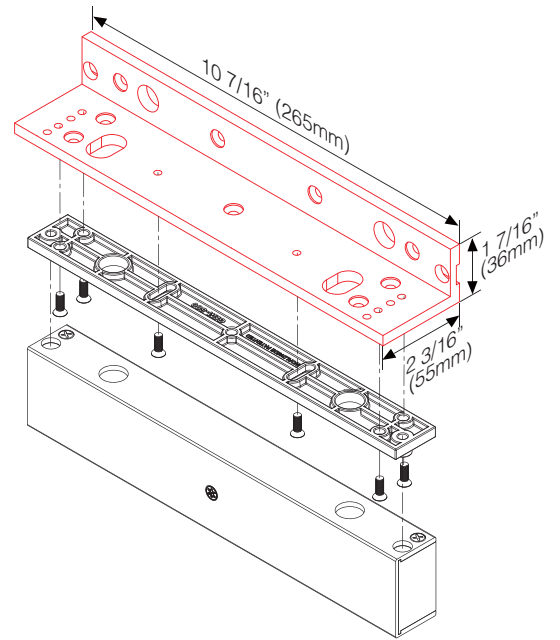

Installation of L bracket on Outswing Doors

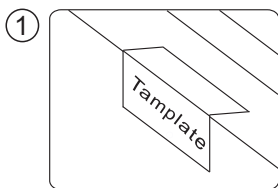

1 Fold the mounting template 90° angle along the dotted line.

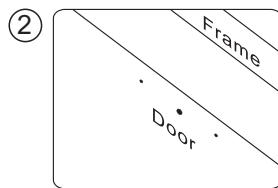

2 Drill the holes marked on the template.

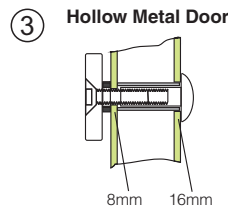

3 Hollow Metal Door
Drill a hole 8 mm in diameter through the door. Enlarge the hole to 16 mm from outside.

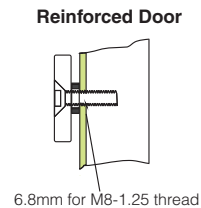

Reinforced Door
Drill a hole 6.8mm in diameter from inside. Screw with a M8-1.25 thread.

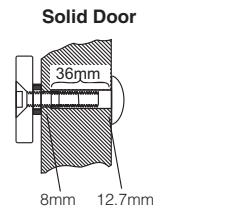

Solid Door
Drill a hole 8mm in diameter through the door. Enlarge the hole to 12.7mm from outside. The thickness of the door is 36mm.

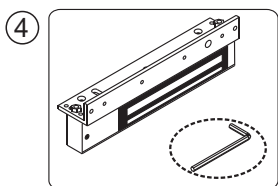

4 Assemble the electromagnet and L bracket with an Allen wrench.

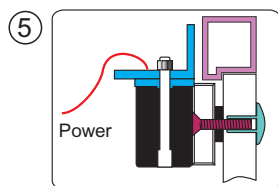

5 Turn on the power of electromagnet. Let the electromagnet and the armature plate bond together. Press L bracket against the door frame.

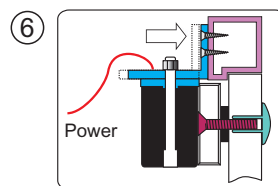

6 Fasten L bracket on the door frame.

Finish

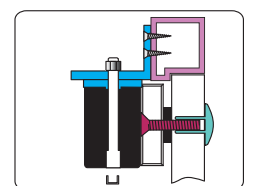

Test the unit. Tap the plugs into the electromagnet