

Inswing doors

LZ-N10001ST Bracket

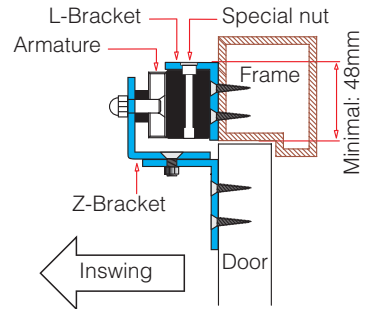

Application for the Electromagnet:
N10001ST series

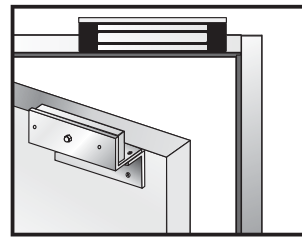
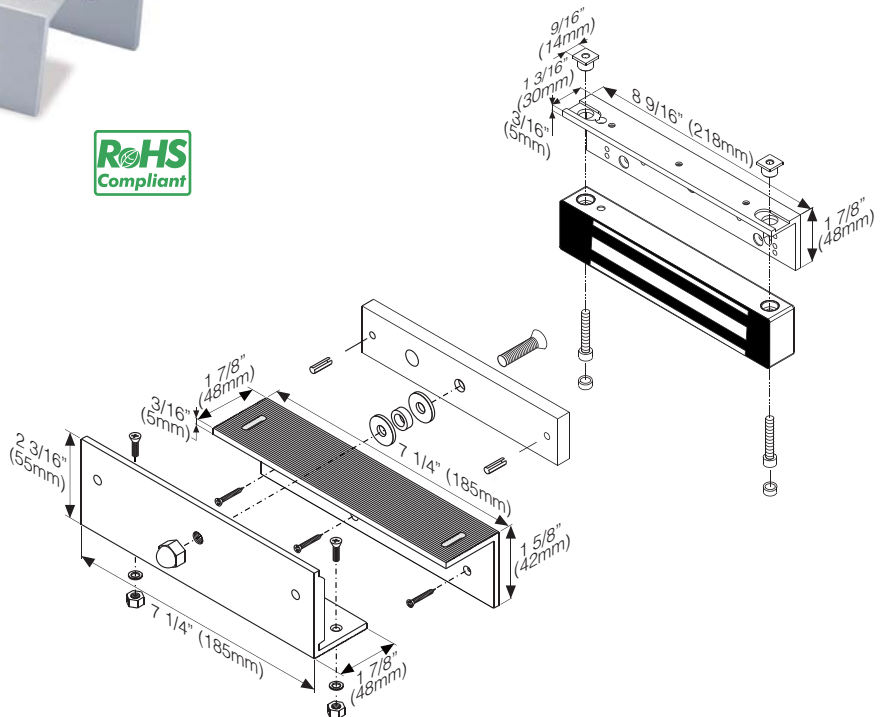

With LZ bracket for inswing doors

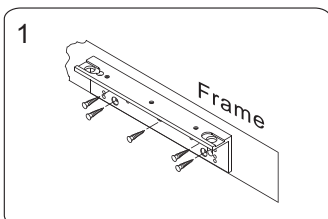

1 Install L bracket on the door frame. Make sure the door may be opened / closed.

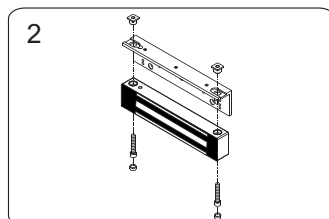

2 Fasten the electromagnet to L bracket with fixing screws.

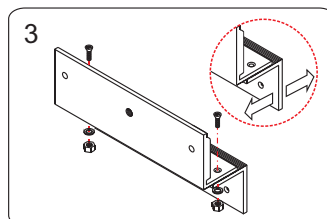

3 Assemble Z bracket. Make sure it is still loose.

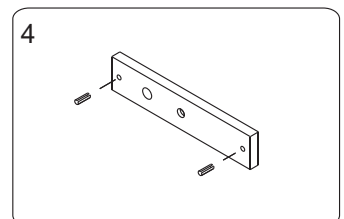

4 Insert the guide pins into the armature plate.

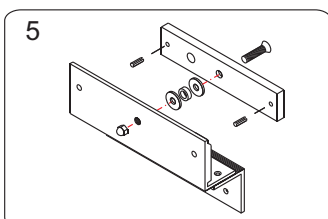

5 Fasten the armature plate to Z bracket. Insert the rubber washer between them.

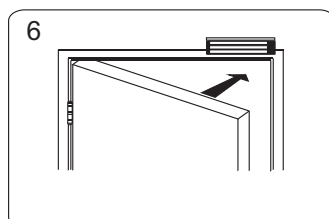

6 Close the door and turn on the power.

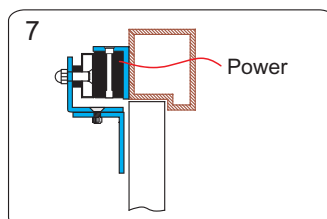

7 Let the armature plate and electromagnet bond together. Press Z bracket to the door leaf.

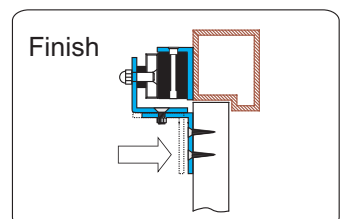

Finish

Fasten Z bracket to the door leaf.