

# Dimension

**EB300**

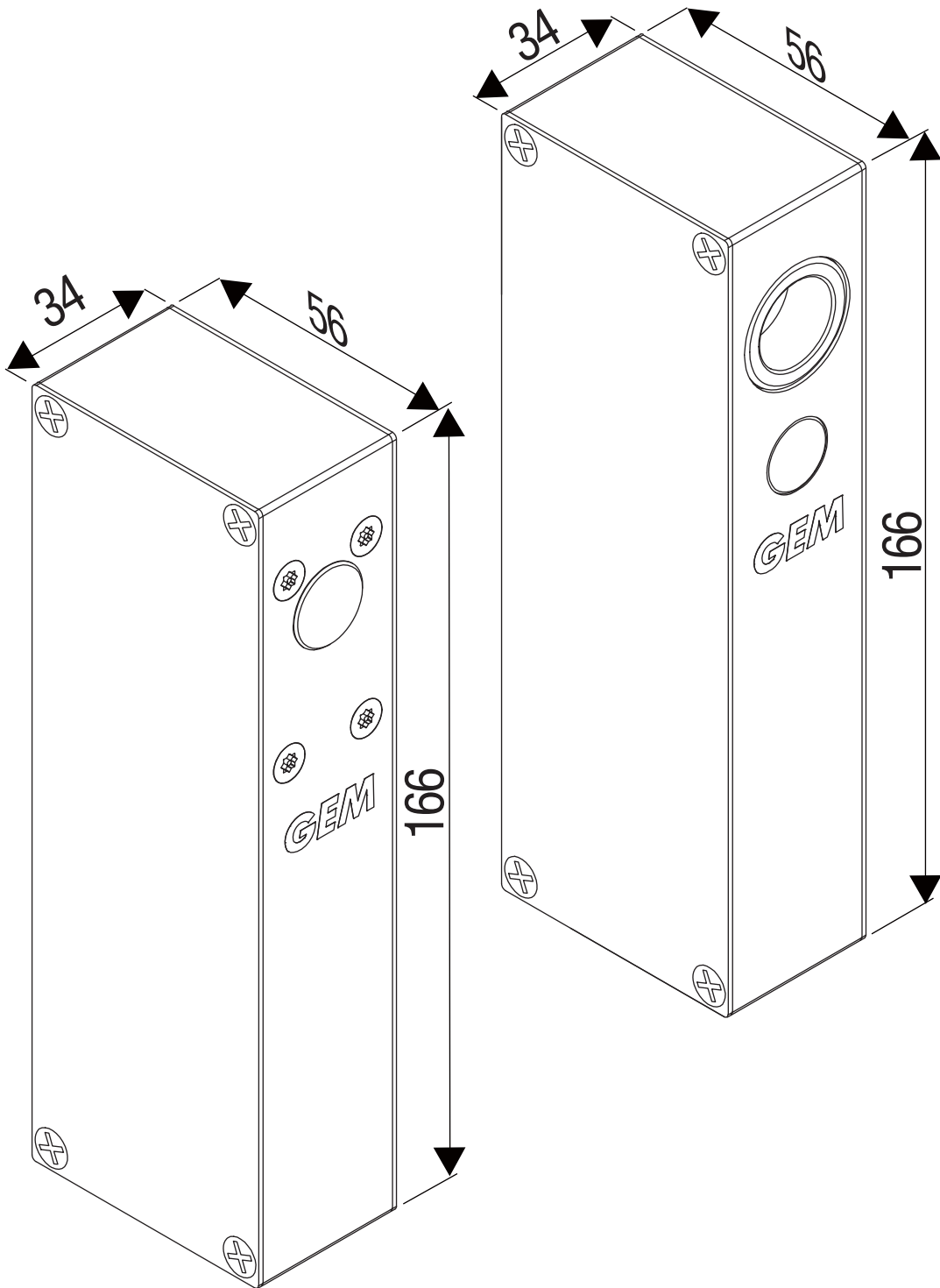

All dimensions in mm