

# Dimension

**GK530**

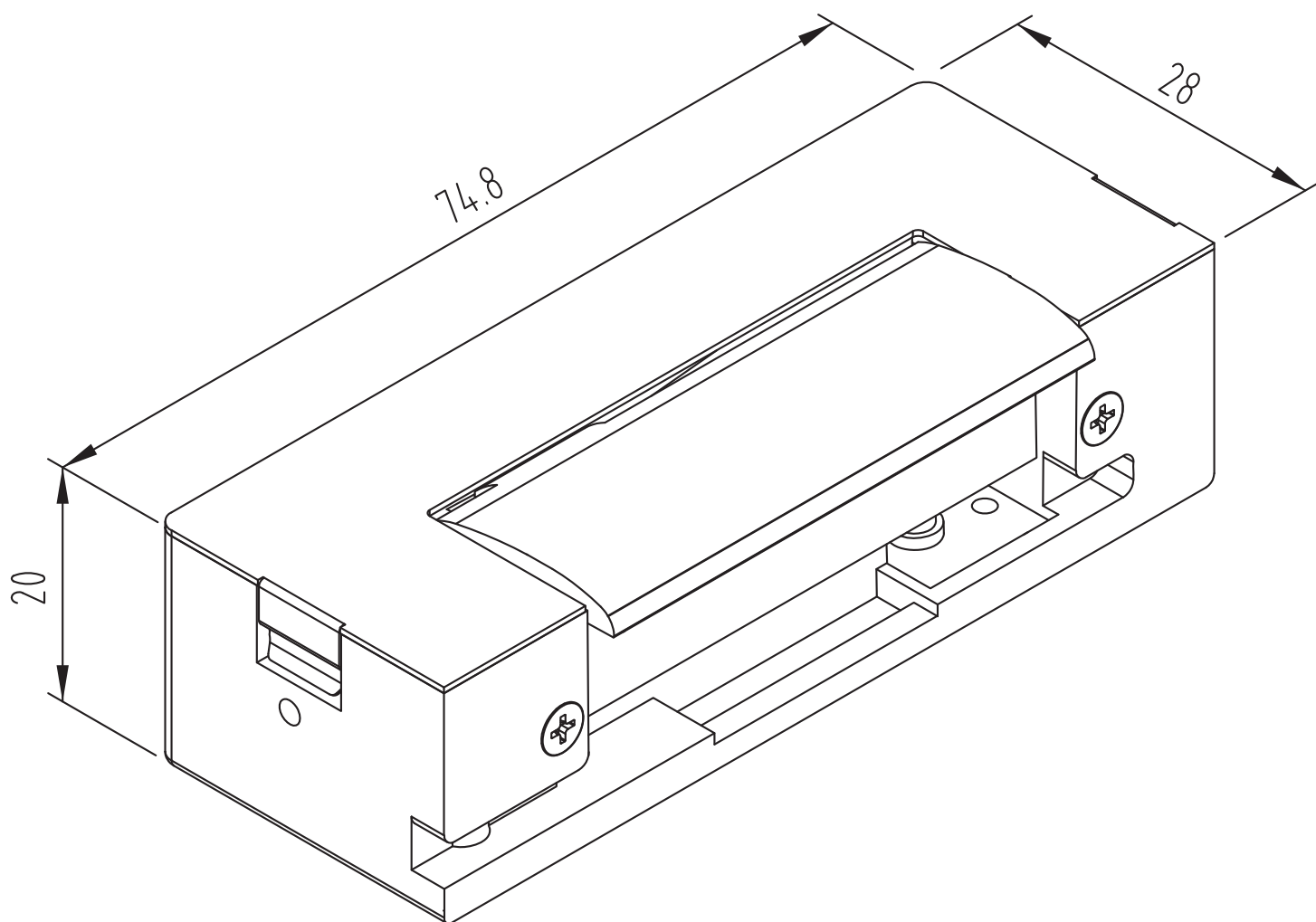

All dimensions in mm