

# Dimension

## GK850

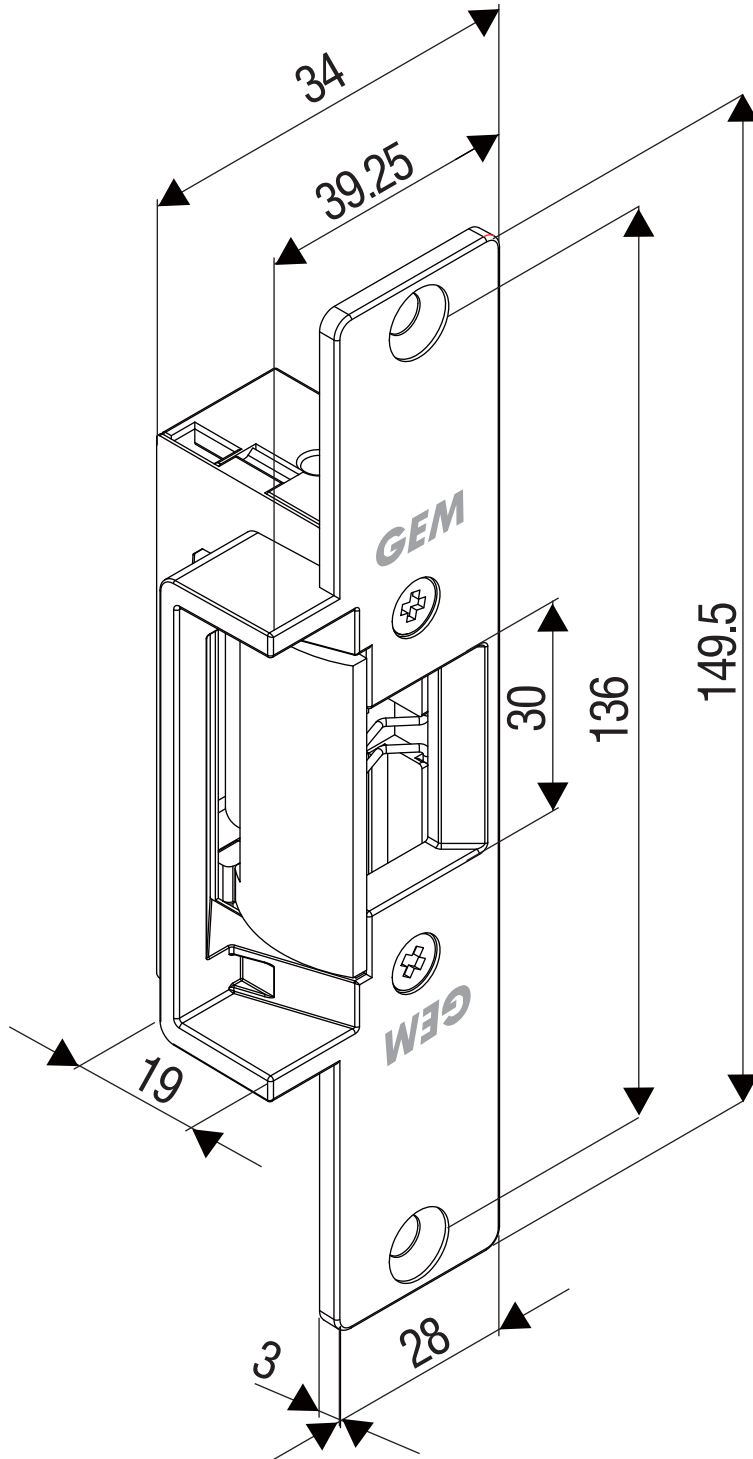

All dimensions in mm