

# Dimension

**KS-800**

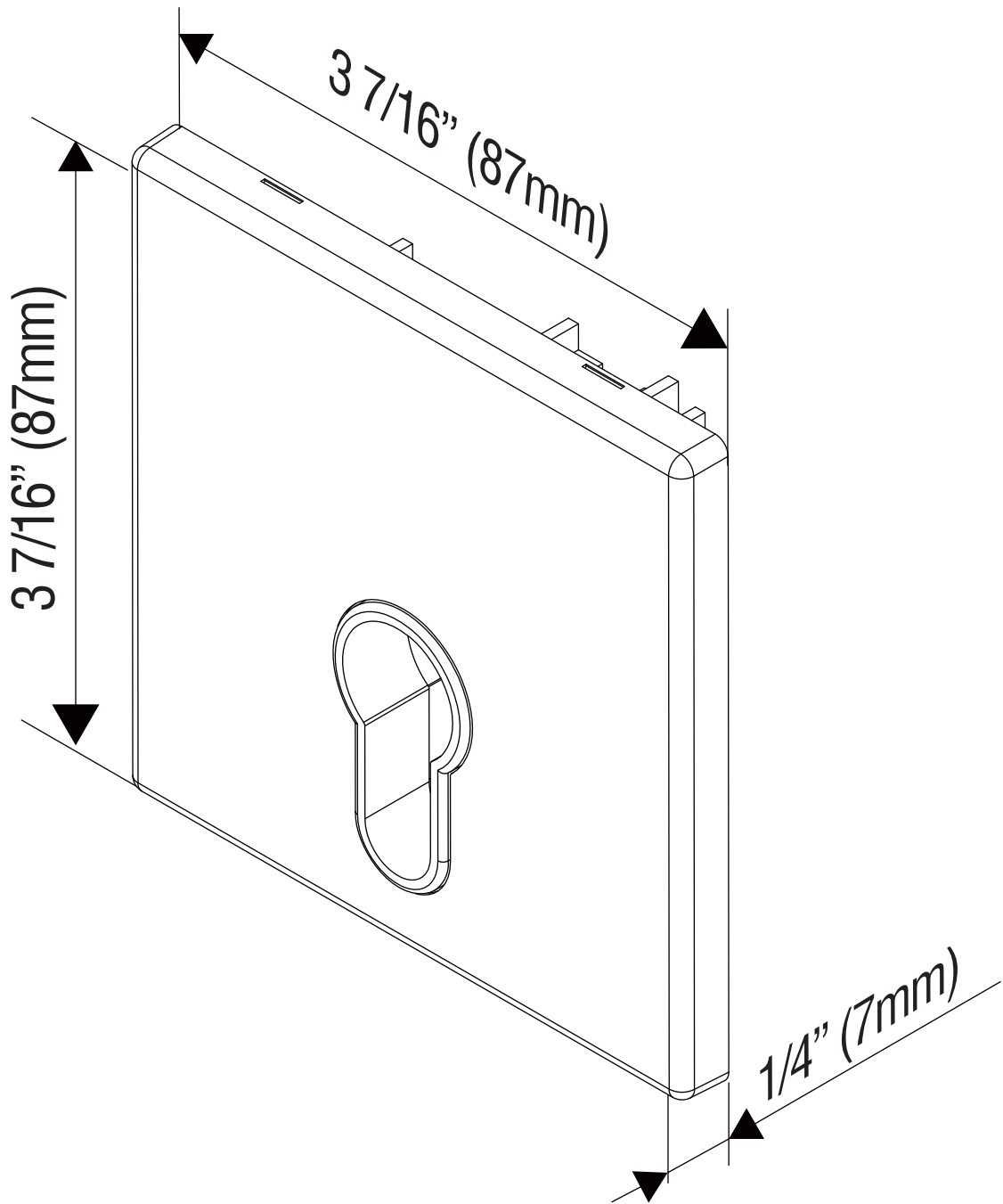

All dimensions in mm