

## ● Statement

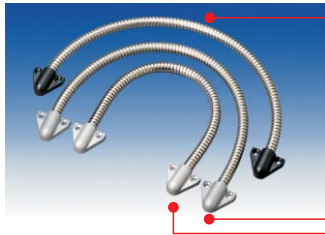

The Door Loops are wire extension protectors that you install on doorframe. It gives attractive and neat result for the wiring; the length of DL-350 and DL-200 metal hose is 40 cm respectively.



**DL-200-1**  
**DL-200-6**  
**DL-200-8**  
 Length: 40cm  
 Triangle plastic sleeve  
 Surface mount

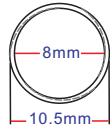

**DL-200W**  
 Length: 40cm  
 Triangle plastic sleeve  
 Surface mount

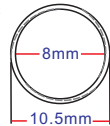

**DL-350**  
 Length: 40cm  
 Square aluminum sleeve  
 Surface mount

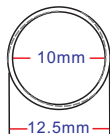

**DL-350-SP**  
 Length: 40cm  
 Square aluminum sleeve  
 Surface mount



**DL-400**  
 Length: 29cm  
 Mortise mount

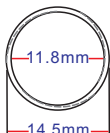

## ● Dimensions

**DL-200**

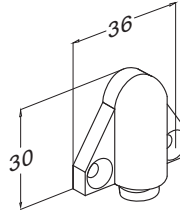

**DL-350**

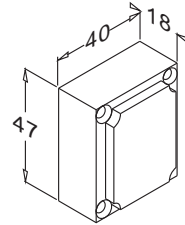

**DL-400**

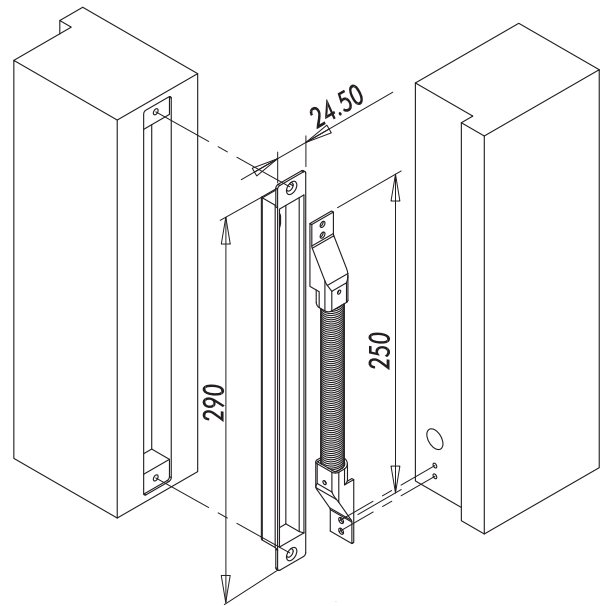

Unit: mm

## ● Application



DL-200, DL-350

## ● Warranty

The product is warranted against defects in material and workmanship while used in normal service for a period of 1 year from the date of sale to the original client. The GEM policy is one of continual development and improvement; therefore GEM reserves the right to change specifications without notice.

## GIANNI INDUSTRIES, INC.

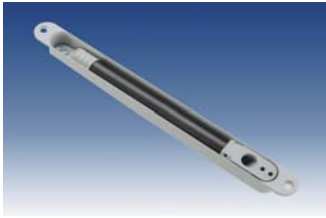

### DL-500

- ▶ Length: 29cm
- ▶  $\phi$ 12.5mm stainless steel flex tube
- ▶ Mortise mount
- ▶ Patent-pending oval-angle box, easy to install

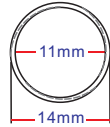

### Dimensions

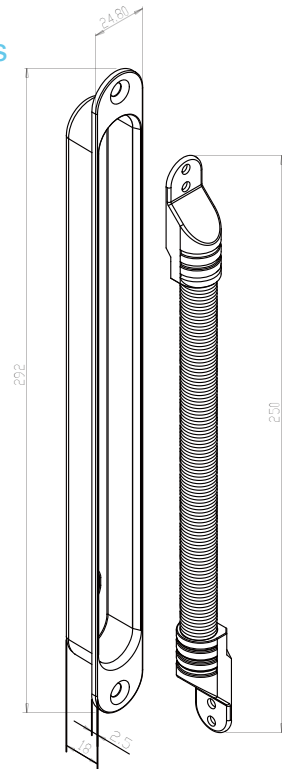

DL-500

Unit: mm