

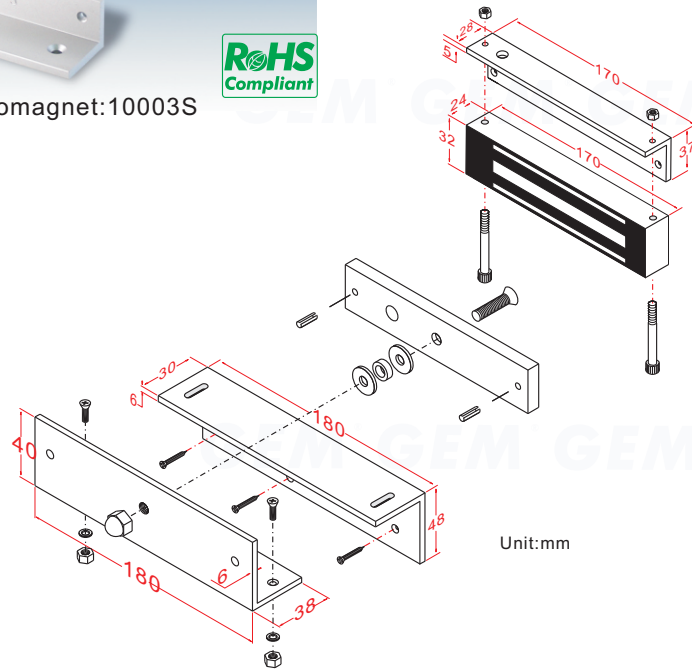

Application for the Electromagnet: 10003S

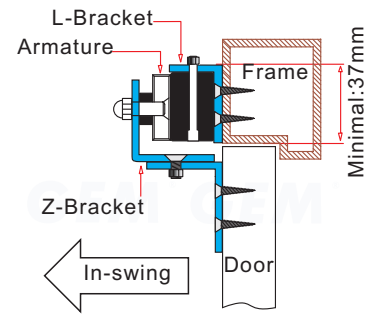

With LZ bracket for in-swing doors

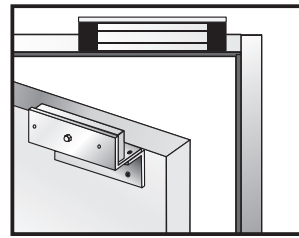
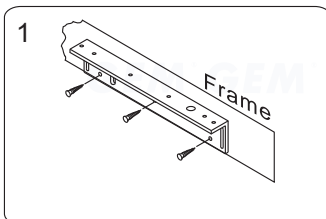

1 Find a mounting location on the door frame for the L bracket. Make sure that the door is still closeable.

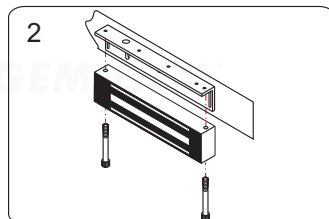

2 Use the fixing bolt to tighten the electromagnet lock on the L bracket

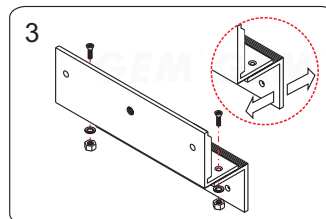

3 Assemble the Z bracket, and make sure that the Z bracket is adjustable.

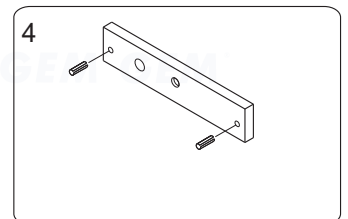

4 Insert the guide pins into the armature plate.

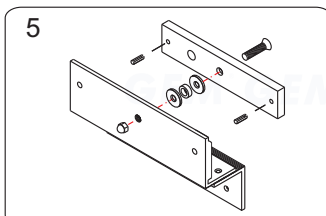

5 Assemble the armature plate and the Z bracket. (Must add rubber washer)

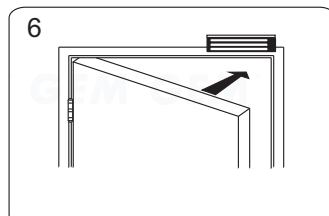

6 Close the door and connect the power.

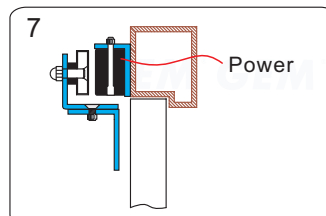

7 Test the tightness and adjust the Z bracket to fit the door.

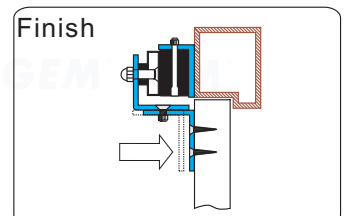

Finish Lock tighten the Z bracket