

PBT-900 series push button is large-sized exit device that is suitable to be installed in a public site where people get in and out frequently. It is easy to push on any position of the durable stainless steel faceplate for the N.O & N.C contacts to change for egression.

Aluminum box (Chromate treatment)



PBT-900ALU-1



PBT-900ALU-2



PBT-900ALU-3

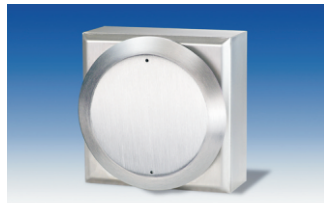

PBT-900ALU-4

Plastic box



PBT-900-1



PBT-900-2



PBT-900-3



PBT-900-4

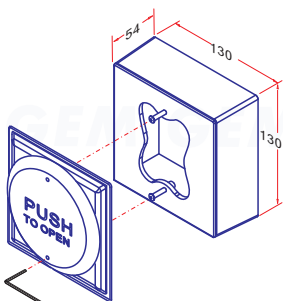

Plastic box

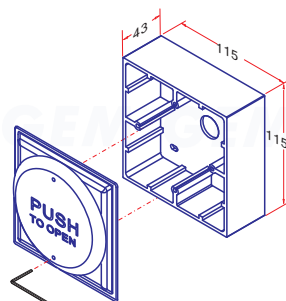

Aluminum box Unit:mm

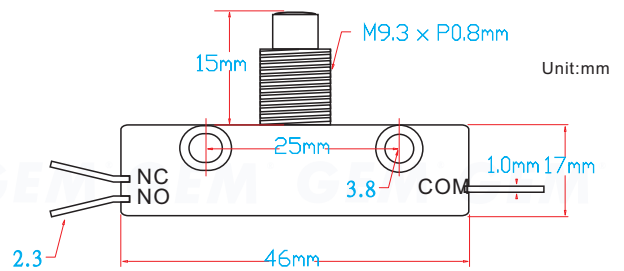
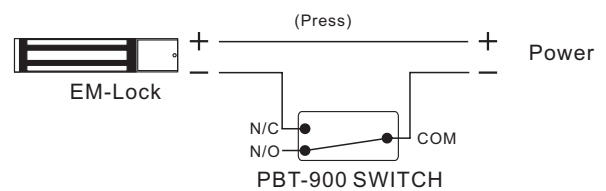
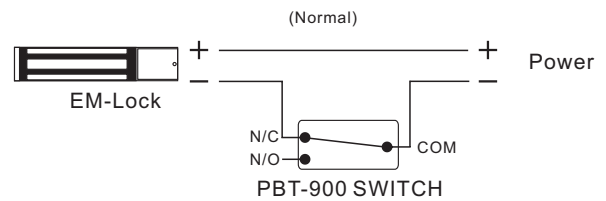
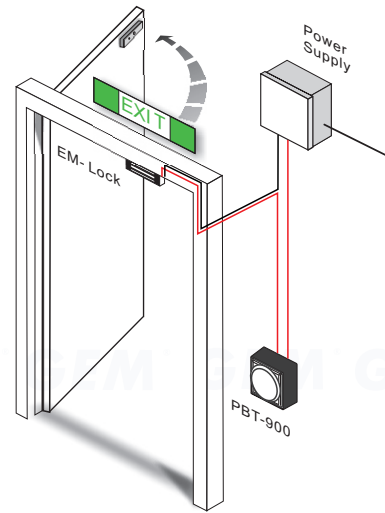

(P-SI-PBT090)

Switch Specifications

Flammability Rating: UL94HB
 Momentary(N/O,N/C,Com) Single Pole Double Throw
 Max. Rating : 15A/125 or 250VAC , 2A/48VDC
 Contact resistance: 50 mΩ Max.(initial)
 Operating life(Mechanical) : Over 100,000 times
 Operating travel: 1.27 mm

GIANNI INDUSTRIES, INC.



PBT-030

Flammability Rating: UL94HB
 Momentary (Com,N/O,N/C)
 Single Pole Double Throw
 Max. Ratings : 15A/125 or 250VAC , 2A/48VDC
 Contact resistance: 50 mΩ Max.(initial)
 Operating life(Mechanical) : Over 100,000 times
 Operating travel: 1.27 mm

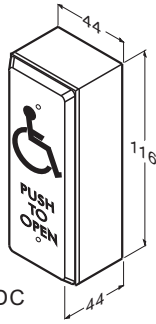

Unit: mm

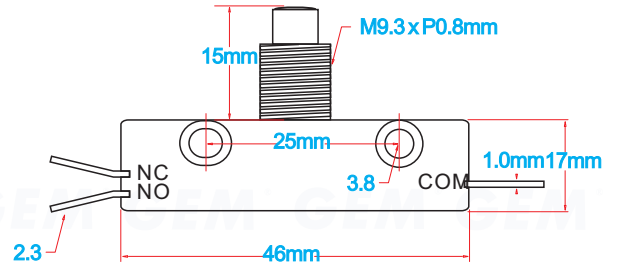

(P-SI-PBT030)



PBT-025JS

Materials: Alluminum Alloy
 Momentary (N/O) Single Pole Single Throw
 Max. Ratings : 5mA/12VDC
 Contact resistance: 1kΩ Max.(initial)
 Operating life(5mA/ 5VDC) : Over 100,000 times
 Operating travel: 1.75mm

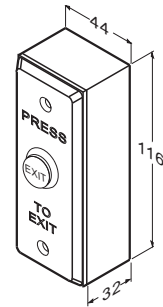

Unit: mm

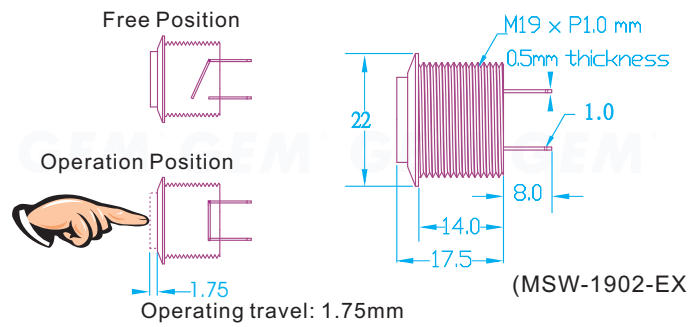

(MSW-1902-EXIT)



PBT-080

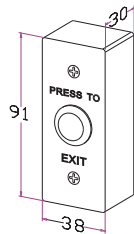

Unit: mm

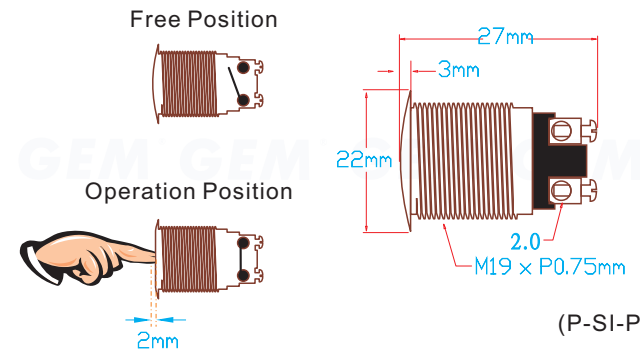

(P-SI-PBT-2)



PBT-090-2

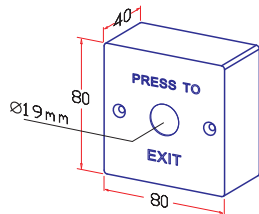

Materials: Stainless steel Faceplate
 Momentary (N/O) Single Pole Single Throw
 Max. Ratings : 5A/125V AC, 6A/24V DC
 Contact resistance: 50 mΩ Max.(initial)
 Operating life(Mechanical) : Over 100,000 times
 Operating travel: 2.0 mm



PBT-090-4

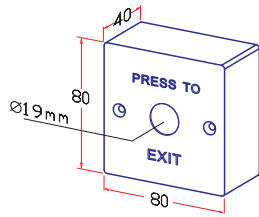

Free Position

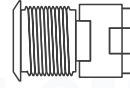

Operation Position

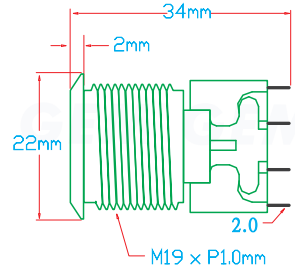
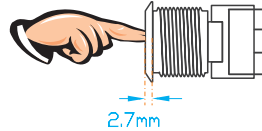

(SWH-040)



PBT-100-4

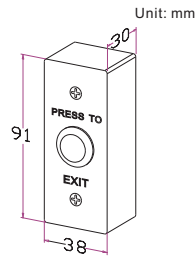

Materials: Stainless steel
 Momentary (N/O,N/C) Double Pole Double Throw
 Max. Ratings : 5A/125/250 VAC
 Contact resistance: 50 mΩ Max.(initial)
 Operating life(Mechanical) : Over 100,000 times
 Operating travel: 2.7 mm
 Cables included



PBT-160

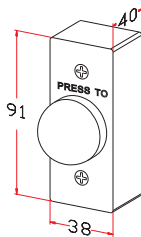

Free Position



Operation Position



Operating travel:
2.7mm

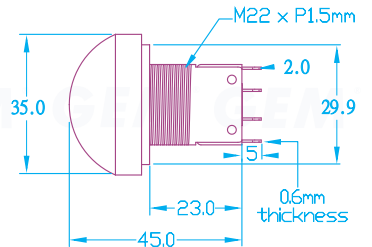

(SWH-160-GE)



PBT-170

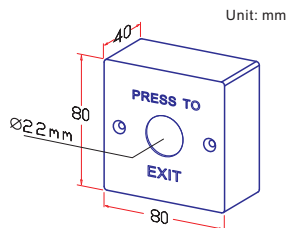

Materials(Button): Zinc alloy, Faceplate: Stainless steel
 Momentary (N/O,N/C) Double Pole Double Throw
 Max. Ratings : 5A/125/250 VAC
 Contact resistance: 50mΩ Max.(initial)
 Operating life(Mechanical) : Over 100,000 times
 Operating travel: 2.7mm