

■ Application of the Electromagnet: GL600-F

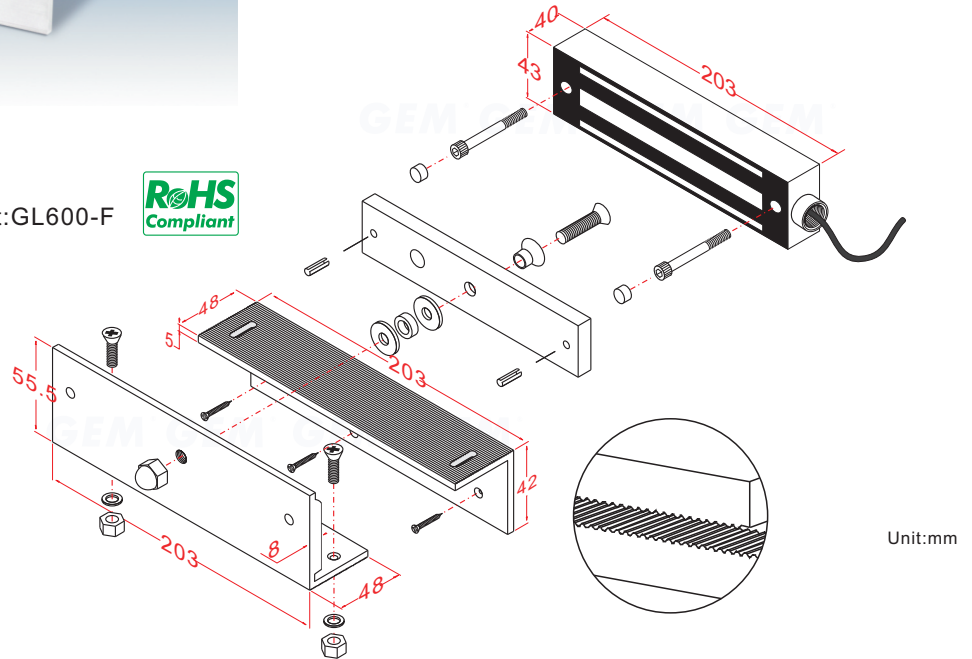

### Installation of Z bracket on In-swing Doors

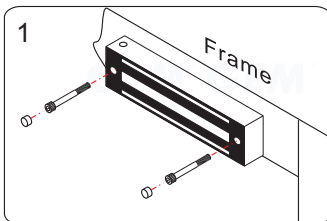

1 Install the electromagnet on the door frame. Make sure the door may be opened/closed.

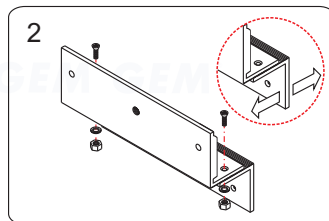

2 Assemble Z bracket. Make sure it is still loose.

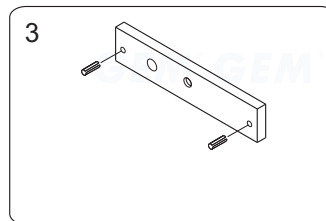

3 Insert the guide pins into the armature plate.

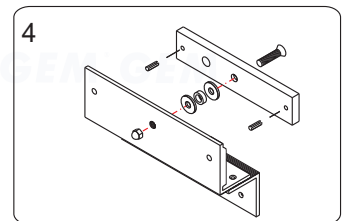

4 Fasten the armature plate to Z bracket. Insert the rubber washer between them.

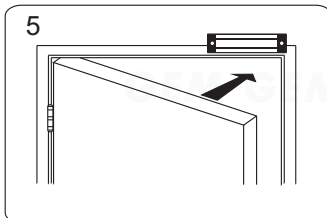

5 Close the door and turn on the power.

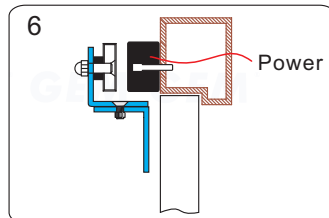

6 Let the armature plate and electromagnet bond together.

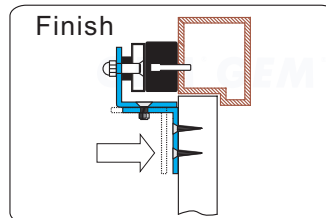

Finish Press Z bracket to the door leaf and fasten it.